

PD Series

Photoelectric Sensors

Features:

- Low Cost
- Non Contact Sensing
- Various Sensing Types
- Low Power Consumption
- Shock Resistant

Description:

The PD Series photoelectric sensors offer superior optical performance in a miniature 18 mm package. Designed specifically for a wide variety of applications, including food processing, packaging, and materials handling. Their miniature size makes it easy to design into any system.

The PD Series provides flawless operation in the harshest environments. Rated NEMA 4, 6, and 13, the PD Series keeps working in wet and high-pressure washdown situations even under water. The PD Series is highly immune to extreme shock and vibration, and passes the NEMA ICS 1-109 showering arc test. Even walkie-talkies won't interfere with it's performance.

PD Series sensors are available in 10-30 VDC thru-beam reflex, and proximity configurations. Infrared, visible-beam, and polarized models are available, as is a complete line of fiber optic cables. Easy alignment is provided by a variable intensity indicator (patents pending) on all models, and by an additional forward-looking alignment indicator on thru-beam models.

The unique "round and square" profile makes installation easy. It can be screwed into standard 18 mm threaded brackets. Bulkhead mounts are mounted flush against any surface. Electrical connections are made via an all purpose cable.

New From KEP—Sensi Prox...

The PD Series introduces a photoelectric breakthrough: SENSI-PROX. Unlike other proximity sensors whose signal strengths drop off gradually, KEP's SENSI PROX proximity sensor has an extremely sharp cut-off. Because of this, SENSI PROX sensors provide superior background suppression and absolute detection at precise distances.

Accessories:

Retroreflectors and mounting brackets are available to complete the installation of your PD Series sensor.



Specifications:

ELECTRICAL (all models)

Input voltage: 10-30 VDC (above 55°C derate to 24 VDC at 70°C)

Power dissipation: 1W max

Response time:

Dark-to-light: 1 mS max

Light-to-dark: 1 mS max

Sensitivity adjustment: 20:1 ratio

Power on delay: <300 mS

Output type and rating:

Source and sink transistors:

Sourcing: 100 mA max

Sinking: 250 mA max (above 55°C, derate sinking output to 120 mA max at 70°C) Off-state voltage: 30 VDC max

Off-state leakage: 10 μ A max

Light/Dark Operation: When the Lt/Dk control is in the Lt position (fully clockwise) the outputs turn on when the beam is complete. When in the Dk position, the outputs turn on when the beam is broken.

Alignment Indicator: LED intensity varies with signal strength to aid alignment. LED status:

OFF: power is off

DIM: power is on, but beam is broken

BRIGHT: power is on, and beam is complete (unbroken). Intensity varies with signal strength.

Mechanical/Environmental:

Operating temperature: -20°C to +70°C (-4°F to +158°F)

Storage temperature: -20°C to +70°C (-4°F to +158°F)

Humidity: 95% RH, noncondensing

Case material: Rigid Polyurethane

Lens material: Polycarbonate

Vibration: 30g or 0.06 in displacement, whichever is less, from 50 Hz to 2 kHz

Shock: 100g for 3 ms 1/2 sine wave pulse

Ratings: NEMA 4, 6, 13

Mounting: Side or 18 mm thru-hole (see dimensions).

Cable Length: 6 feet

Side mounting: Use #4 screws to attach the sensor to a wall or mounting bracket. Thru-hole mounting: The sensor can be mounted through an 18 mm (0.71 in) diameter hole using nuts included with the sensor.

NOTE: All sensors UL and CSA approved.

WIDE-ANGLE THRU-BEAM
PDS 25 — 10-30 VDC source
PDD 25 — 10-30 VDC detector
Maximum range: 25 ft.
Effective beam: 0.25 in diameter
Field of view: 40 in. at 100 in.
Sunlight immunity: 10,000 footcandles

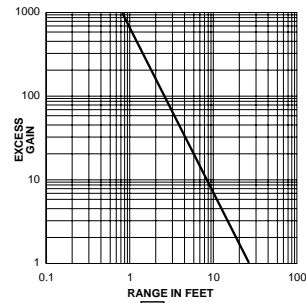

VISIBLE-BEAM SENSI
PROX (Diffused)
PROXIMITY
PDP02 — 10-30 VDC

This sensor has a precise gain cut-off (from an excess gain of 20 to 1 in 150-thousandths of an inch) which makes it ideal for applications in which background suppression is necessary. This sensor also emits a visible beam of light for easy alignment.
Maximum range: 2.25 in.
Optimum range: 0 to 2.25 in.
Detection spot diameter: 0.1 in. at 2 in.
Sunlight immunity: 10,000 footcandles

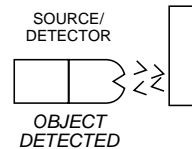
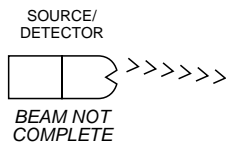
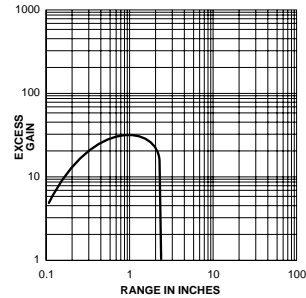

SHORT-RANGE PROXIMITY (Diffused)
PDP08 — 10-30 VDC
Maximum range: 8.0 in.
Optimum range: 0 to 4.0 in.
Field of view: 2 in. at 5 in.
Sunlight immunity: 10,000 footcandles

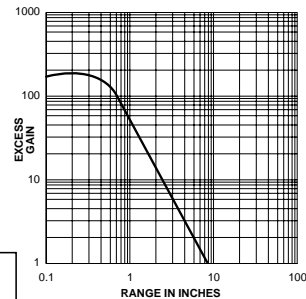
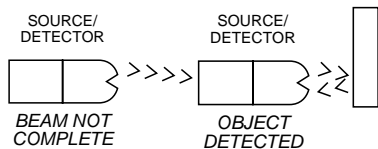

VISIBLE-BEAM REFLEX
PDR25 Series — 10-30 VDC
This sensor emits a visible beam of light for easy alignment.
Maximum range: 25 ft.
Optimum range: 0 to 15 ft.
Field of view: 2 in. at 100 in.
Sunlight immunity: 10,000 footcandles

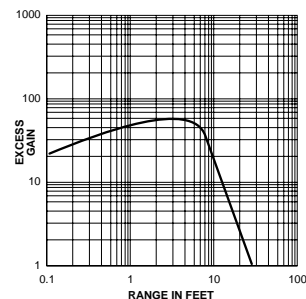
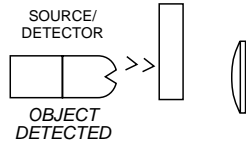
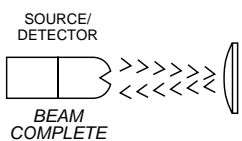

POLARIZED VISIBLE-BEAM REFLEX
PDR15 Series — 10-30 VDC

The polarized reflex sensor responds only to light reflected from a hard surface retroreflector as T3.0 or T.5. It does not respond to most reflective tapes nor shiny objects. This feature is important in applications where shiny objects such as cans or bottles are to be detected. This sensor also emits a visible beam of light for easy alignment.

Maximum range: 15 ft.
Optimum range: 0 to 10 ft.
Field of view: 1 in. at 50 in.
Sunlight immunity: 10,000 footcandles

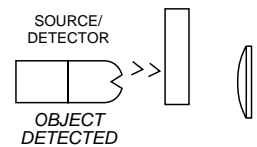
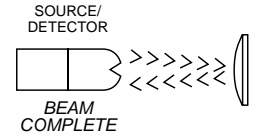
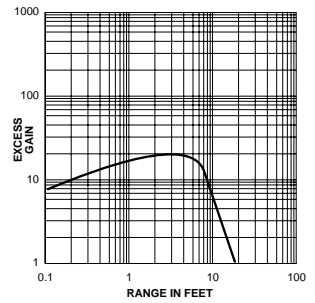

FIBER OPTIC SENSOR
PDF Series — 10-30 VDC

Special purpose sensor for use with the plastic fiber optic cable family. Fiber optic cables plug into sockets on the front of the sensor. Sensor operates in thru-beam or proximity mode depending on the fiber optic cable selected.

Maximum range:
0.65 in. for 0.04 in. fiber optic cables in proximity mode.
6 in. for 0.04 in. fiber optic cables in thru-beam mode.
0.3 in. for 0.02 in. fiber optic cables in proximity mode.
1.5 in. for 0.02 in. fiber optic cables in thru-beam mode.
Field of view: Depends on fiber optic cable selected
Sunlight immunity: 10,000 footcandles

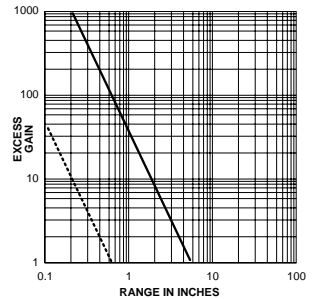

----- Prox Performance
— Thru-Beam Performance

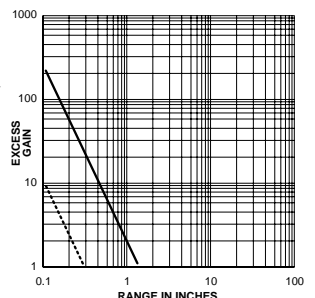

----- Prox Performance
— Thru-Beam Performance

HOW TO PICK THE RIGHT SENSOR

1) Most applications can be satisfied with a reflex unit, one that sends out a light signal to bounce off a reflector back to the source. This unit is ideal for sensing ranges from 1" to 15 ft. Use P/N PDR Series and order a PDA T.5 or PDA T3.0 reflector.

BOX COUNTING

MODEL #	DESCRIPTION
PDR25	Reflex Sensor
PDA3.0	Retroreflector

A single reflex control detects boxes anywhere on a four foot wide conveyor. Interfacing the control with a KEP counter provides totals.

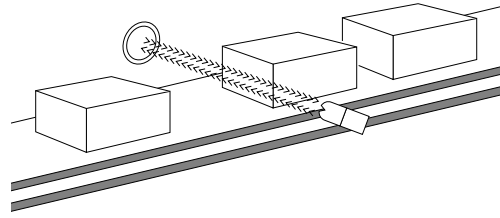

2) If you have shiny objects to be detected like metal cans or covered in shiny shrink wrap that might accidentally act as a refl and trip the sensor, use the Polarized reflex unit. It works best to 10 feet. Use a PDR15 and a hard surface target reflector.

BATCH COUNTING AND DIVERTING

MODEL#	DESCRIPTION
PDR15	Polarized Reflex Sensor
PDAT3.0	Retroreflector

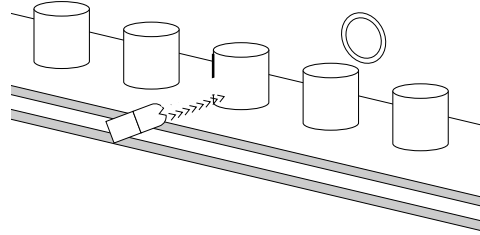

3) If you can look directly at the object to be sensed and there are no objects to false trigger the unit, you only need to look 4 inches or less to see the object. Use PDP08.

4) If you want to look out only 2 inches and ignore objects very close to that range, we have a special product with total background suppression. Use PDP02.

FILTER PAPER LENGTH CONTROL

MODEL #	DESCRIPTION
PDP02	Sensi Prox

A fixed-focus proximity control with the standard output interfaces with a KEP Counter to measure a specific length of corrugated automotive filter

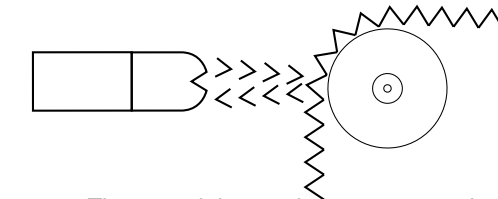

paper. The control detects the presence or absence of a corrugation. When a predetermined number of corrugations has been detected, the Keptrol or Intellect counter closes a relay, which directs a shear to cut the paper.

5) If you have to look very far or if you are looking thru a very smokey or dirty area, thru beam sensors are the most powerful type of photo-electrics because the light only travels one way. It leaves the source and is received at the detector. Of course, you will have to buy and wire two separate units for a thru beam application. Use PDS25 and PDD 25.

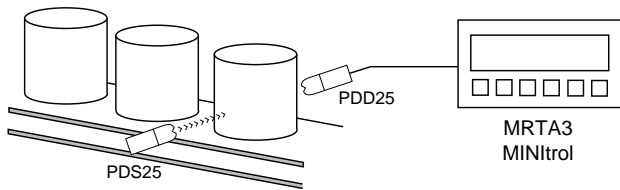

PDABA BRACKET

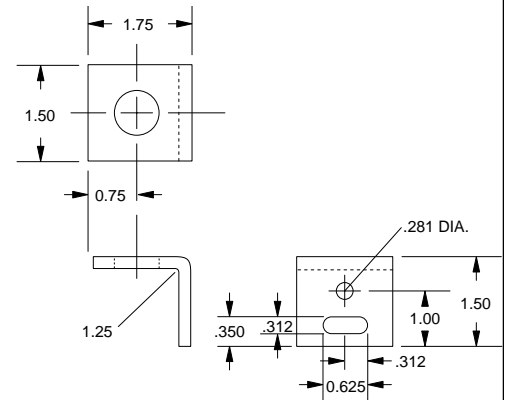

PDABS SWIVEL BRACKET

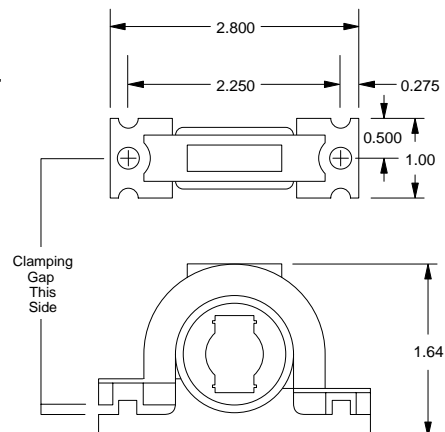

6) Now if you really have some special requirements — small space, high temperature, intrinsic safety needs or very small object detection, use our Fiber Optic Unit. Use P/N PDF00 with appropriate fibers ordered separately.

